

MAGNUM-X

Spot light

- >> very high luminous intensity
- >> efficient thermal design
- >> good homogeneity
- >> available with different secondary optics
- >> for continuous, switched and pulsed operation
(depending on type)

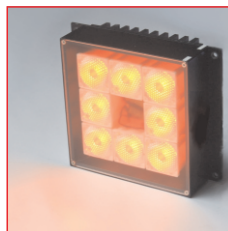

MAGNUM-X red

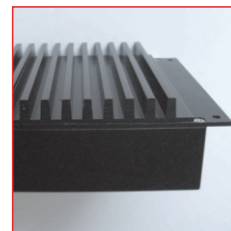

MAGNUM-X rear side with heatsink

Technical specifications



Housing	Aluminium, black or natural anodised
Front cover (within the scope of supply)*	Acrylic clear, antireflective coating 2mm
Total weight	approx. 430g
Operating / ambient temperature	max. 50°C recommended
IP protection class	depending on the version
Connector	M8 plug (4-pin)**
Supply voltage***	24VDC type or 12VDC type: 24VDC resp. 12VDC SC type: For use in conjunction with a controller
Number of LEDs	8 High-Power LEDs
LED lifetime	The LED lifetime of our lights is very high, but depends on many different factors such as ambient temperature, current load, and so on. Further information is available in the Technical information LED lifetime .
* more information and further front covers see section Accessories	
** Cable not included in the scope of supply	
*** more information see section Operating modes	

Characteristics

Colour *	LED characteristics		typical characteristics per light				
	Wavelength (approx.)	Secondary optic	Current demand (24V type) ** / constant current max. (SC type) [mA]	Pulse current max. (SC type) *** [A]	Intensity **** [W/m²]		
					Type N	Type M	Type W
red	617nm	N, M, W	280	1,7	120		
white	6500K	N, M, W	570	3,8		104	
IR	850nm	N, M, W	325	2,4	185		

* other colours and types from UV to infrared on request

** stated current values of the 24V types should be considered approximate values

*** depending on the strobe conditions, recommended maximum values for a flash time of 1ms

**** approximately data measured in DC mode; Measuring distance 250mm



Safety note!

LED light systems can produce very intense radiation, which may possibly damage the eyes on improper use. Do not look directly into the light beam with unprotected eyes! Use eye protection!

Operating modes

24VDC type / 12VDC type

The lights are designed depending on the version for continuous operation at 24VDC or 12VDC.

The following operating modes are possible:

- DC operation at an appropriate power supply with 24VDC or 12VDC
- Switched operation with a matching power supply e.g. via PLC, opto-relay or controller (GS or SC series)
- Brightness-controlled operation via controller (GS or SC series) in conjunction with suitable power supply
- Pulsed mode via controller (GS or SC series) in conjunction with suitable power supply. The LED current can be increased in pulse mode up to a factor of 2 to 3.

SC type

For pulsed, switched or brightness-controlled operation, the lights are also available as optimized SC versions. They can be used in combination with our controllers of the GS and SC series and provide optimized and maximum current flow, especially in pulsed operation. We will assist you in selecting the right components.

technical changes reserved

Büchner Lichtsysteme GmbH

Uzstrasse 2
86465 Welden
Germany

Tel.: +49 (0)8293 | 909 112
Fax: +49 (0)8293 | 909 111

E-mail: info@buechner-lichtsysteme.de
Web: www.buechner-lichtsysteme.de

www.imaging-light-technology.com

IMAGING LIGHT TECHNOLOGY
BÜCHNER

Dimensions

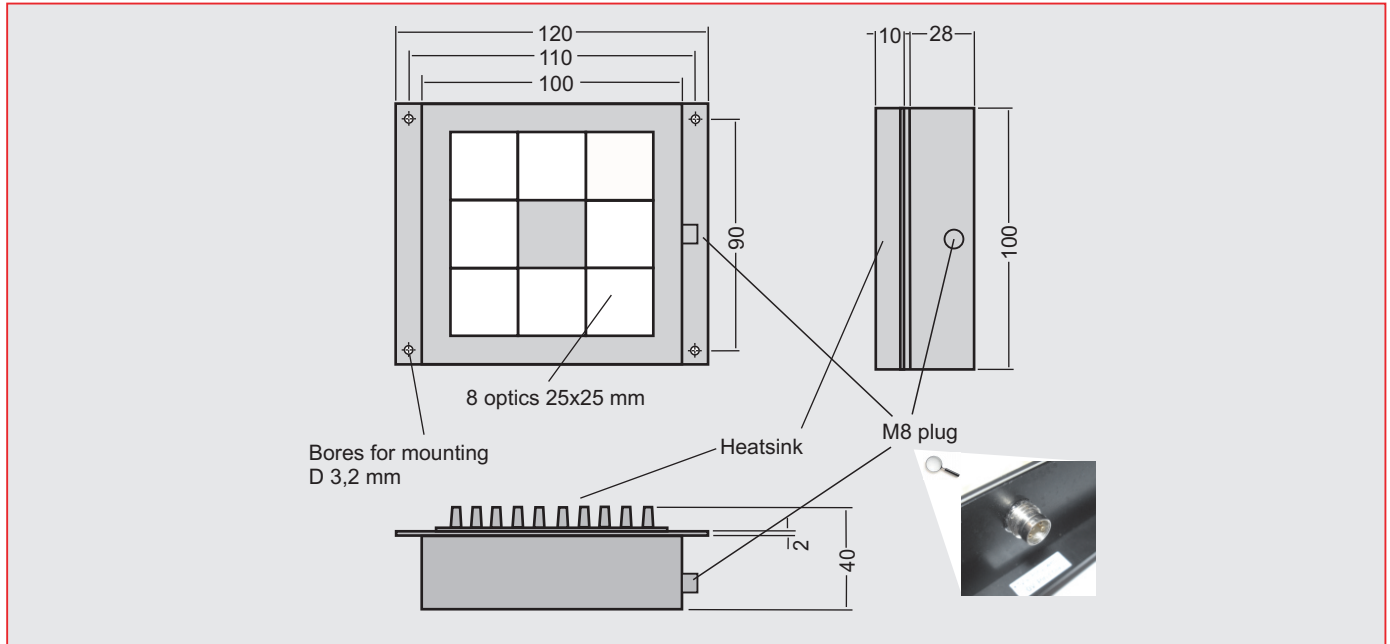

PIN assignment connector

M8 plug 4-pin
(Front view on housing)

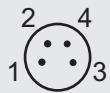

24VDC type

PIN	Colour	Function
1	brown	+ 24V
3	blue	-

12VDC type

PIN	Colour	Function
2	white	+ 12V
3	blue	-

SC type

PIN	Colour	Function
4	black	+
3	blue	-

Secondary optics

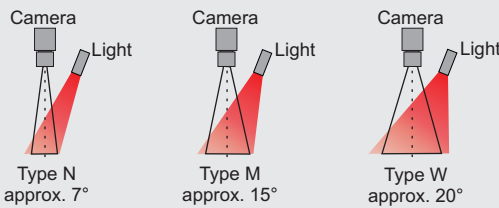

By using different secondary optics, the photometric properties of the lighting can be adapted to the respective application.

Application notes (Incident light)

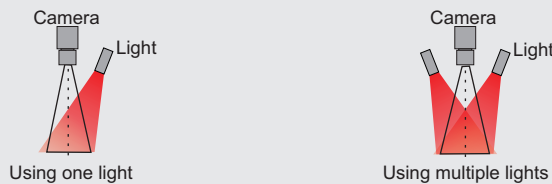

Light which hits the surface from a specific angle physically produces a slightly inhomogeneous light spot, depending on the inclination. By using a symmetrical arrangement of several lights this occurring intensity drop can be compensated and increases additionally the intensity in the field of view.

Accessories

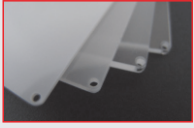

Front covers / diffusers

Through the use of different diffuse front covers, the optical characteristics of the illumination can be changed.

More information can be found in the **Technical information Front materials**.