

DOME-170

Dome light

- >> large-sized dome light
- >> extremely homogeneous, diffuse illumination
- >> optional segment control (4, 8 or 16 channels)
- >> optional front cover for the LED structure
- >> for continuous, switched and pulsed operation (depending on type)

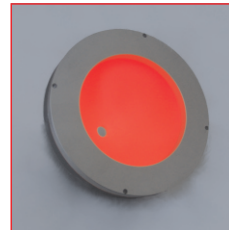

DOME-170 red



DOME-170

Technical specifications



Housing	Aluminium, high-quality plastic
Total weight	approx. 655g
Operating / ambient temperature	max. 50°C recommended
IP protection class	depending on the version
Connector	M8 plug (4-pin) / 4-Channel-Operation: M8 plug (6-pin) / 8-/16-Channel-Operation: M12 plug (17-pin) *
Supply voltage**	24VDC type or 12VDC type: 24VDC resp. 12VDC SC type: For use in conjunction with a controller
Number of LEDs	64
LED lifetime	The LED lifetime of our lights is very high, but depends on many different factors such as ambient temperature, current load, and so on. Further information is available in the Technical information LED lifetime .

* Cable not included in the scope of supply
** more information see section Operating modes

Characteristics

Colour *	LED characteristics		typical characteristics per light		
	Wavelength (approx.)	Viewing angle	Current demand (24V type) ** / constant current max. (SC type) [mA]	Pulse current max. (SC type) *** [mA]	Intensity **** [W/m ²]
red	635nm	120°	140	800	8
white	6500K	120°	230	800	40
IR	850nm	120°		3200	

- * other colours and types from UV to infrared on request
- ** stated current values of the 24V types should be considered approximate values
- *** depending on the strobe conditions, recommended maximum values for a flash time of 1ms
- **** approximately data measured in DC mode; Measuring distance 10mm below housing



Safety note!

LED light systems can produce very intense radiation, which may possibly damage the eyes on improper use. Do not look directly into the light beam with unprotected eyes! Use eye protection!

Operating modes

24VDC type / 12VDC type

The lights are designed depending on the version for continuous operation at 24VDC or 12VDC. The following operating modes are possible:

- DC operation at an appropriate power supply with 24VDC or 12VDC
- Switched operation with a matching power supply e.g. via PLC, opto-relay or controller (GS or SC series)
- Brightness-controlled operation via controller (GS or SC series) in conjunction with suitable power supply
- Pulsed mode via controller (GS or SC series) in conjunction with suitable power supply. The LED current can be increased in pulse mode up to a factor of 2 to 3.

SC type

For pulsed, switched or brightness-controlled operation, the lights are also available as optimized SC versions. They can be used in combination with our controllers of the GS and SC series and provide optimized and maximum current flow, especially in pulsed operation. We will assist you in selecting the right components.

technical changes reserved

Büchner Lichtsysteme GmbH

Uzstrasse 2 Tel.: +49 (0)8293 | 909 112 E-mail: info@buechner-lichtsysteme.de
86465 Welden Fax: +49 (0)8293 | 909 111 Web: www.buechner-lichtsysteme.de
Germany www.imaging-light-technology.com



DOME-170

Dome light

Dimensions

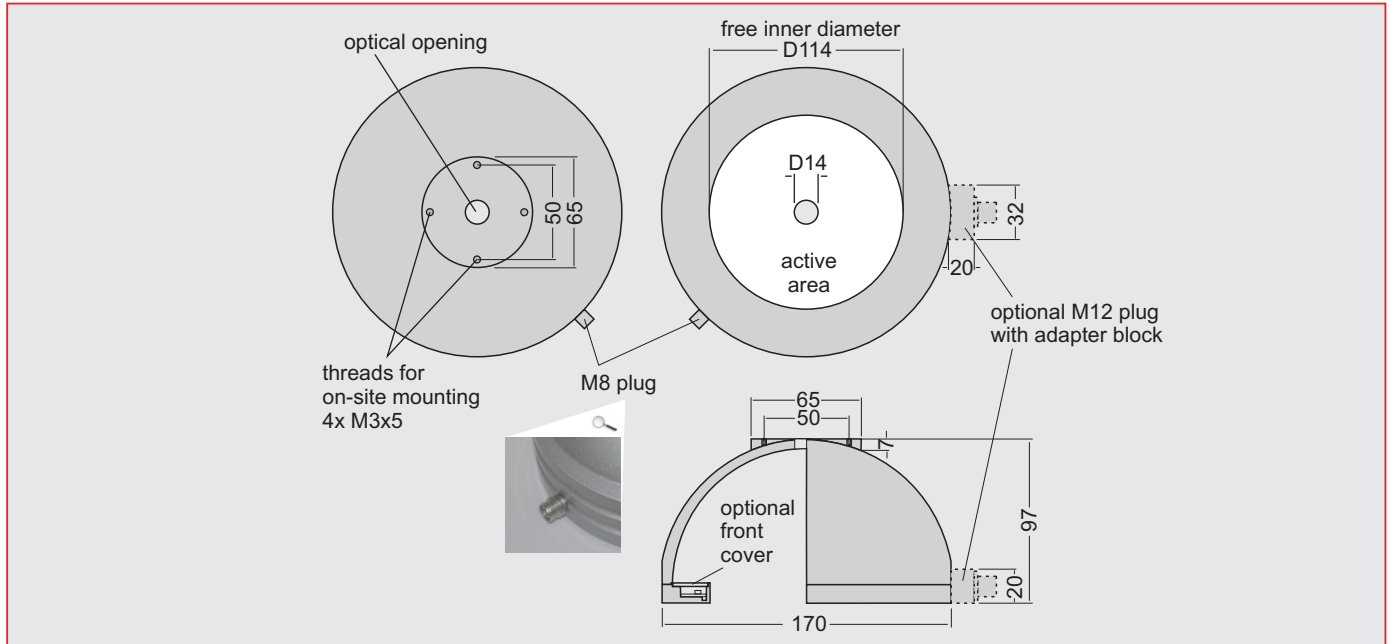

PIN assignment connector

M8 plug 4-pin
(Front view on housing)

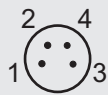

24VDC type

PIN	Colour	Function
1	brown	+ 24V
3	blue	-

12VDC type

PIN	Colour	Function
2	white	+ 12V
3	blue	-

SC type

PIN	Colour	Function
4	black	+
3	blue	-

M8 plug 6-pin
(Front view on housing)

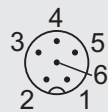

24VDC type

PIN	Colour	Function
1	brown	+ 24V
3	blue	- Ch. 1
4	black	- Ch. 2
5	grey	- Ch. 3
6	rose	- Ch. 4

12VDC type

PIN	Colour	Function
2	white	+ 12V
3	blue	- Ch. 1
4	black	- Ch. 2
5	grey	- Ch. 3
6	rose	- Ch. 4

SC type

PIN	Colour	Function
4	black	+ common
3	blue	- Ch. 1
2	white	- Ch. 2
5	grey	- Ch. 3
6	rose	- Ch. 4

M12 plug 17-pin
(Front view on housing)

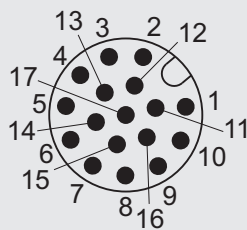

24VDC type

PIN	Colour	Function
17	white/grey	+ 24V
1	brown	- Ch. 1
2	blue	- Ch. 2
3	white	- Ch. 3
4	green	- Ch. 4
5	rose	- Ch. 5
6	yellow	- Ch. 6
7	black	- Ch. 7
8	grey	- Ch. 8

12VDC type

PIN	Colour	Function
		+ 12V
		- Ch. 1
		- Ch. 2
		- Ch. 3
		- Ch. 4
		- Ch. 5
		- Ch. 6
		- Ch. 7
		- Ch. 8

SC type

PIN	Colour	Function
		+ common
		- Ch. 1
		- Ch. 2
		- Ch. 3
		- Ch. 4
		- Ch. 5
		- Ch. 6
		- Ch. 7
		- Ch. 8

technical changes reserved

Büchner Lichtsysteme GmbH

Uzstrasse 2 Tel.: +49 (0)8293 | 909 112
86465 Welden Fax: +49 (0)8293 | 909 111
Germany

E-mail: info@buechner-lichtsysteme.de
Web: www.buechner-lichtsysteme.de

www.imaging-light-technology.com

●●● IMAGING ● LIGHT ● TECHNOLOGY
BÜCHNER

DOME-170

Dome light

Application notes

Dome application

The optical opening for the camera is located symmetrically on the top of the dome and has a diameter of 14mm. Other diameters on request!

The DOME is typically positioned close to the object.

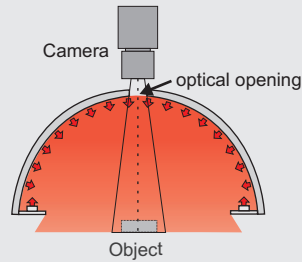

Options

The DOME-170 can optional be configured so that the LED ring can be controlled in 4, 8 or 16 segments, which are all individually controllable. Therefore other connectors are used, dependent on the number of channels: M8 (4-pin) (1 channel), M8 (6-pin) (4 channels) or M12 (17-pin) (8 and 16 channels).

Accessories

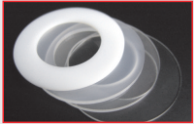

Front covers / diffusers

Through the use of different diffuse front covers, the optical characteristics of the illumination can be changed. In addition, the LED structure of the DOME-170 is protected. More information can be found in the **Technical information Front materials**.